

**ESCO**  
SCIENTIFIC



# Labculture® G4

**Class II Type A2 Biological Safety Cabinets**

*The Most Advanced Energy-efficient, Safe,  
and Ergonomic Biosafety Cabinet in the World*



# LABCULTURE® G4 (LA2 G4) CLASS II TYPE A2 BIOSAFETY



## USB Port

- Export Data Logging
- Software Update
- Wired data transaction to BMS



## Zero Volt Relay Contact

- Free Relay Contact
- Exhaust Free Relay Contact

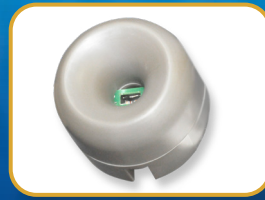

## Airflow Sensor

- Monitors real-time airflow for safety
- Alert the user if airflow is insufficient

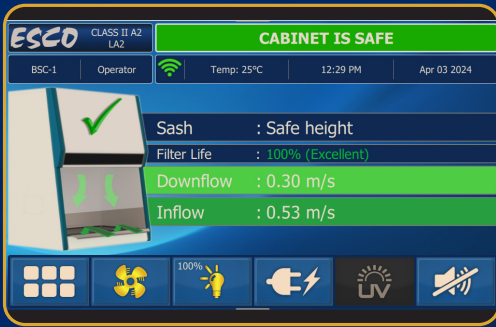

## Centurion 7" Capacitive Touchscreen Controller

- Displays all safety information on one large screen
- Shows cabinet parameters with intuitive 3D illustration
- Easy to use menu, similar to Smart Phone Apps
- Large buttons, easy to operate when wearing gloves
- Self-guidance to users to deal with specific situations
- Centered and angled down for easy reach and viewing
- Optional: 21 CFR Part 11 Compliance
- Wireless data transaction to BMS



## Single Piece Wall

- Easy to reach service fixtures and electrical outlets on sidewalls
- Large radius corners for easy cleaning



## User-friendly Work Tray

- Largest useable area in the market
- Recessed to contain spillage
- Sloped perimeter for easy cleaning
- Large, easy to clean tray handle
- Work tray holder for drain pan cleaning



## Raised Arm Rest

- Prevent grille blocking
- Comfortable working posture
- Durable stainless steel construction



## Ergonomic Work Zone

- 10° angle to optimize user comfort, reduce glare, and maximize reach into the work area
- Brightly illuminated with >1200 lux (111 ft. cd)
- Industry-leading dimmable LED for optimum work comfort
- Airtight seal port for cable/tube exit protected by a negative pressure side wall



Esco Labculture® G4 Class II Type A2 Biosafety Cabinet  
Available in 3 feet, 4 feet, 5 feet, and 6 feet models.

# CABINET, FEATURING ADVANCED TOUCHSCREEN CONTROLLER

## Energy-efficient DC ECM Blower

- The leading energy efficient Class II Type A2 Biosafety Cabinet in the world with 70% energy savings compared to AC motor
- Stable airflow despite building voltage fluctuations and filter loading
- Standby mode to further reduce power consumption by 80%

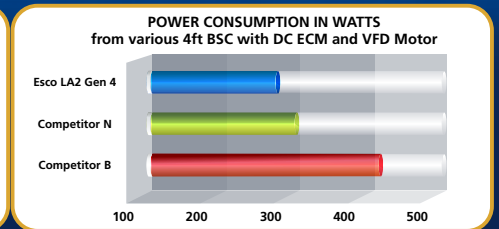
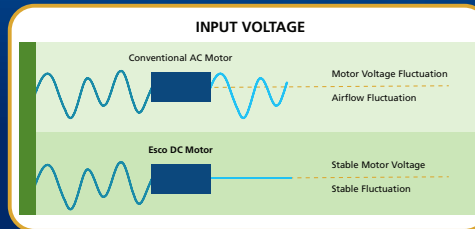

## Advanced ULPA Filtration System

- 10x Filtration efficiency of HEPA filter
- Creates ISO Class 3 work zone instead of industry-standard ISO Class 5
- Same 10 years filter life and replacement cost as HEPA filters

Note:  
 • 99.999% at 0.1 to 0.3 micron, ULPA as per IEST-RP-CC001.3 USA  
 • 99.999% at MPPS, H14 as per EN 1822 EU



## Dimmable LED

- Save energy and optimize work comfort



## Removable Paper Catch

- Prevent objects from being pulled into blower plenum
- Removable for easy cleaning
- Optional pre-filter can be fitted



## Tray Support Beams

- Support work tray evenly for less vibration
- Cleaning holder to easily wipe the drain pan

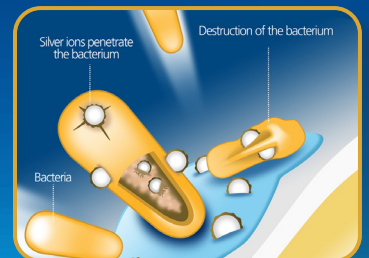

## ISOCIDE™ Powder Coat

- Silver-ion impregnated powder coat
- Inhibits microbial growth to improve safety
- Prevents the plenum from becoming biohazard landfill

## Certification

	Performance	Air Quality	Filtration	Electrical Safety
Standards Compliance	NSF / ANSI 49, USA	ISO 14644.1, Class 3, Worldwide US Fed Std 209E, Class 1 USA JIS B9920, Class 3, Japan	EN-1822 (H14), Europe IEST-RP-CC001, USA	UL 61010-1 3rd Ed, USA CSA22.2, No.1010-192, Canada IEC61010-1, Worldwide

## Dynamic Chamber™

- Blower plenum and side walls are surrounded by negative pressure
- Prevent contaminants from escaping outside

■ Positive Pressure  
 ■ Negative Pressure

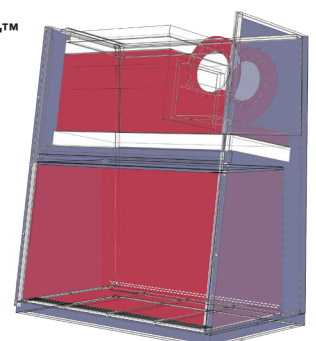

## Cabinet Filtration System

- Ambient air is pulled through front grille to create inflow, without going into the work surface. Inflow is joined by half of the downflow, to create front air curtain that is fine-tuned to create a large performance envelope. The combined air stream travels through the back air column towards the blower.
- Approximately 1/3 of the air in the common plenum is exhausted through the ULPA filter to the room. The remaining 2/3 of the air is passed through the downflow ULPA filter and into the work area as a vertical laminar flow air to create ISO Class 3 work surface and prevents cross contamination.
- Near the work surface, the downflow splits. About half goes to the front grille, and half goes to the rear grille. A small portion enters the side capture zones to prevent dead air corners (small blue arrows).
- The design was optimized to give large performance envelope, that provides operator and product protection at wide Inflow and Downflow variation from the Nominal point.

## The Performance Envelope Concept

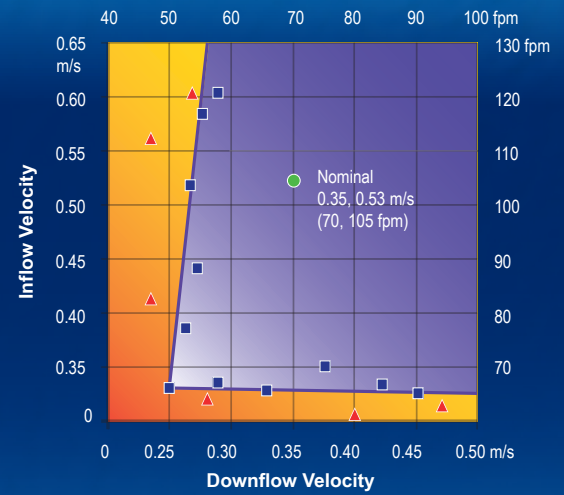

- Nominal Airflow
- Personnel / Product Protection
- Area of Personnel / Product Protection
- ▲ No Personnel / Product Protection
- Area of no Personnel / Product Protection

Dynamic air barrier, where inflow and downflow converge  
Side capture zones

- ULPA-filtered air
- Unfiltered / potentially contaminated air
- Room air / Inflow air

## Engineering Drawing

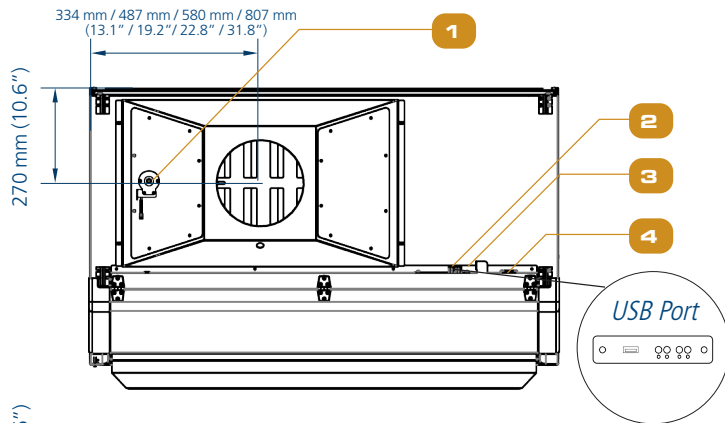

1. Exhaust sensor
2. USB Port
3. Zero Volt Relay Contact
4. Power Inlet
5. Centurion Touchscreen Controller
6. 10° Angled Sash Window
7. Maximum Sash Opening
8. Single-piece Stainless Steel Back Wall
9. Single-piece Stainless Steel Work Tray
10. Electrical Panel
11. Dimmable LED Lamp
12. IV Bar Retrofit Kit Provision
13. Service Fixture Retrofit Kit Provision
14. Cable Port (NSF Approved)
15. Stainless Steel Arm Rest
16. Exhaust Collar (optional)
17. Exhaust Filter
18. DC ECM Blower
19. Downflow Filter
20. UV Lamp Provision
21. Electrical Outlet Provision

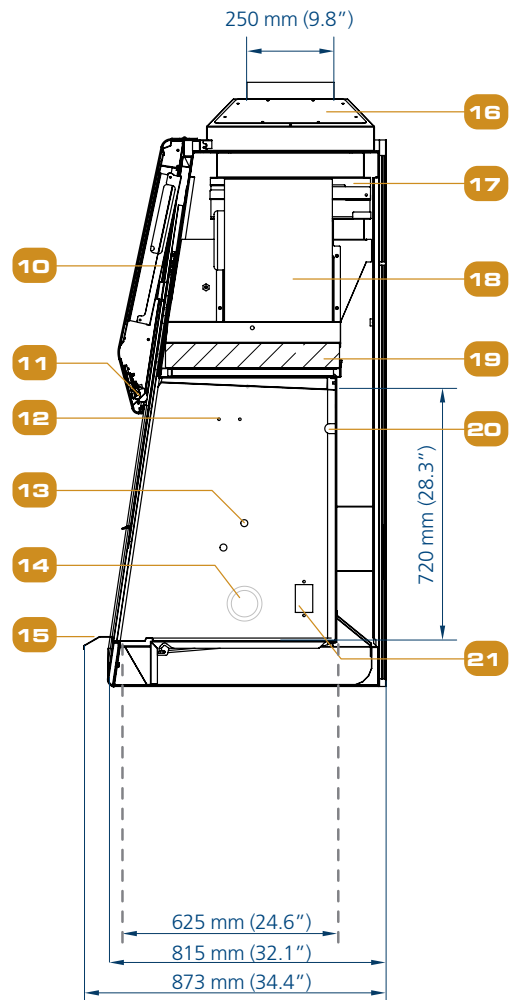
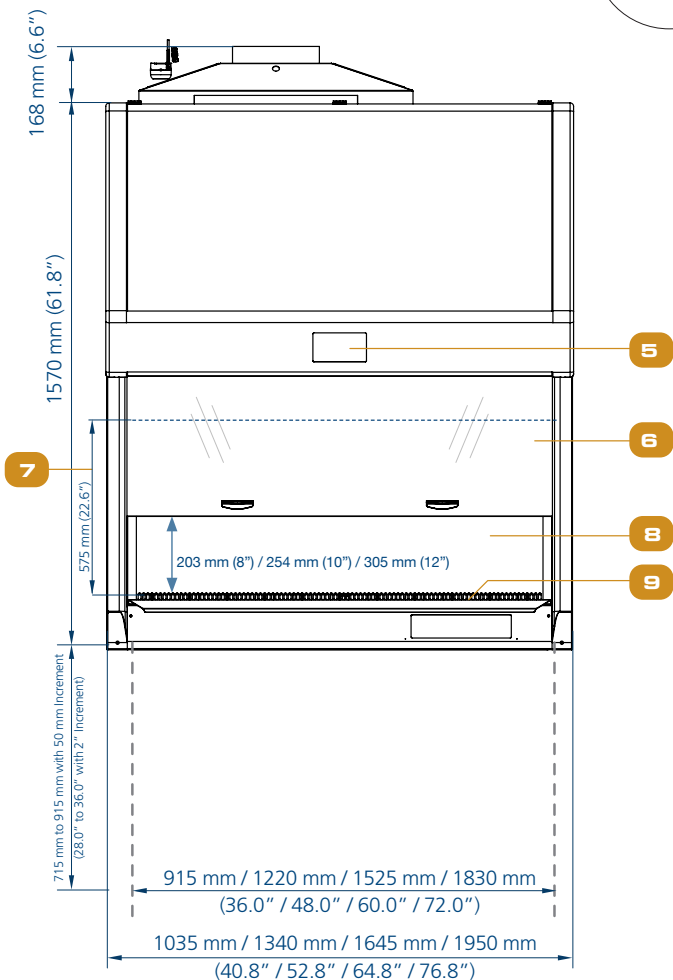

## TECHNICAL SPECIFICATIONS

Labculture® Class II	Stainless Steel Side Walls	220-240 VAC, 50/60 Hz	LA2-3S8 G4 8" 2011666	LA2-4S8 G4 8" 2011668	LA2-5S8 G4 8" 2011670	LA2-6S8 G4 8" 2011672
			LA2-3S8 G4 10" 2011682	LA2-4S8 G4 10" 2011684	LA2-5S8 G4 10" 2011686	LA2-6S8 G4 10" 2011688
			LA2-3S8 G4 12" 2011714	LA2-4S8 G4 12" 2011716	LA2-5S8 G4 12" 2011718	LA2-6S8 G4 12" 2011720
		110-130 VAC, 50/60 Hz	LA2-3S9 G4 8" 2011667	LA2-4S9 G4 8" 2011669	LA2-5S9 G4 8" 2011671	LA2-6S9 G4 8" 2011673
			LA2-3S9 G4 10" 2011683	LA2-4S9 G4 10" 2011685	LA2-5S9 G4 10" 2011687	LA2-6S9 G4 10" 2011689
			LA2-3S9 G4 12" 2011715	LA2-4S9 G4 12" 2011717	LA2-5S9 G4 12" 2011719	LA2-6S9 G4 12" 2011721
<b>Nominal Size</b>			0.9 meter (3')	1.2 meter (4')	1.5 meter (5')	1.8 meter (6')
<b>External Dimensions* (W x D x H)</b>	Without Arm Rest		1035 x 815 x 1570 mm (40.8" x 32.1" x 61.8")	1340 x 815 x 1570 mm (52.8" x 32.1" x 61.8")	1645 x 815 x 1570 mm (64.8" x 32.1" x 61.8")	1950 x 815 x 1570 mm (76.8" x 32.1" x 61.8")
	With Arm Rest		1035 x 873 x 1570 mm (40.8" x 34.4" x 61.8")	1340 x 873 x 1570 mm (52.8" x 34.4" x 61.8")	1645 x 873 x 1570 mm (64.8" x 34.4" x 61.8")	1950 x 873 x 1570 mm (76.8" x 34.4" x 61.8")
<b>Internal Dimensions (W x D x H)</b>			915 x 625 x 720 mm (36.0" x 24.6" x 28.3")	1220 x 625 x 720 mm (48.0" x 24.6" x 28.3")	1525 x 625 x 720 mm (60.0" x 24.6" x 28.3")	1830 x 625 x 720 mm (72.0" x 24.6" x 28.3")
<b>Usable Work Area</b>			0.47 m <sup>2</sup> (5.0 sq. ft.)	0.63 m <sup>2</sup> (6.8 sq. ft.)	0.80 m <sup>2</sup> (8.5 sq. ft.)	0.96 m <sup>2</sup> (10.3 sq. ft.)
<b>Sash opening</b>		Available in 203 mm (8"), 254 mm (10"), and 305 mm (12")				
<b>Maximum Sash Opening</b>		575 mm (22.6")				
<b>Average Airflow Velocity</b>	Inflow	203 mm (8")	0.53 m/s (105 fpm)			
		254 mm (10")	0.53 m/s (105 fpm)			
		305 mm (12")	0.53 m/s (105 fpm)			
	Downflow	203 mm (8")	0.30 m/s (60 fpm)	0.30 m/s (60 fpm)	0.30 m/s (60 fpm)	0.30 m/s (60 fpm)
		254 mm (10")	0.33 m/s (65 fpm)	0.30 m/s (60 fpm)	0.33 m/s (65 fpm)	0.30 m/s (60 fpm)
		305 mm (12")	0.35 m/s (70 fpm)	0.30 m/s (60 fpm)	0.35 m/s (70 fpm)	0.35 m/s (70 fpm)
<b>Airflow Volume</b>	Inflow	203 mm (8")	356 m <sup>3</sup> /h (210 cfm)	473 m <sup>3</sup> /h (280 cfm)	593 m <sup>3</sup> /h (350 cfm)	709 m <sup>3</sup> /h (420 cfm)
		254 mm (10")	446 m <sup>3</sup> /h (263 cfm)	591 m <sup>3</sup> /h (350 cfm)	741 m <sup>3</sup> /h (438 cfm)	887 m <sup>3</sup> /h (525 cfm)
		305 mm (12")	535 m <sup>3</sup> /h (315 cfm)	710 m <sup>3</sup> /h (420 cfm)	890 m <sup>3</sup> /h (525 cfm)	1065 m <sup>3</sup> /h (629 cfm)
	Downflow	203 mm (8")	581 m <sup>3</sup> /h (345 cfm)	771 m <sup>3</sup> /h (461 cfm)	967 m <sup>3</sup> /h (567 cfm)	1156 m <sup>3</sup> /h (691 cfm)
		254 mm (10")	639 m <sup>3</sup> /h (374 cfm)	848 m <sup>3</sup> /h (499 cfm)	1063 m <sup>3</sup> /h (624 cfm)	1272 m <sup>3</sup> /h (748 cfm)
		305 mm (12")	678 m <sup>3</sup> /h (397 cfm)	771 m <sup>3</sup> /h (461 cfm)	1128 m <sup>3</sup> /h (662 cfm)	1349 m <sup>3</sup> /h (794 cfm)
	Exhaust	203 mm (8")	356 m <sup>3</sup> /h (210 cfm)	473 m <sup>3</sup> /h (280 cfm)	593 m <sup>3</sup> /h (350 cfm)	709 m <sup>3</sup> /h (420 cfm)
		254 mm (10")	446 m <sup>3</sup> /h (263 cfm)	591 m <sup>3</sup> /h (350 cfm)	741 m <sup>3</sup> /h (438 cfm)	887 m <sup>3</sup> /h (525 cfm)
		305 mm (12")	535 m <sup>3</sup> /h (315 cfm)	710 m <sup>3</sup> /h (420 cfm)	890 m <sup>3</sup> /h (525 cfm)	1065 m <sup>3</sup> /h (630 cfm)
<b>Additional Static Pressure for Optional Thimble Exhaust Collar (Measured 360mm or 14" from the top of exhaust collar)</b>		203 mm (8")	15-25 Pa	25-35 Pa	20-30 Pa	40-50 Pa
		254 mm (10")	20-30 Pa	35-45 Pa	25-35 Pa	55-65 Pa
		305 mm (12")	25-35 Pa	45-55 Pa	40-50 Pa	65-75 Pa
<b>Required Exhaust with Optional Thimble Exhaust Collar</b>		203 mm (8")	390 m <sup>3</sup> /h (230 cfm)	529 m <sup>3</sup> /h (311 cfm)	622 m <sup>3</sup> /h (366 cfm)	780 m <sup>3</sup> /h (459 cfm)
		254 mm (10")	480 m <sup>3</sup> /h (283 cfm)	637 m <sup>3</sup> /h (375 cfm)	770 m <sup>3</sup> /h (453 cfm)	944 m <sup>3</sup> /h (556 cfm)
		305 mm (12")	569 m <sup>3</sup> /h (335 cfm)	756 m <sup>3</sup> /h (445 cfm)	921 m <sup>3</sup> /h (542 cfm)	1133 m <sup>3</sup> /h (667 cfm)
<b>ULPA Filter Typical Efficiency</b>		≥99.999% for particle size between 0.1 to 0.3 microns				
<b>Sound Emission (dBA)*</b>	NSF / ANSI 49	203 mm (8")	57	57	60	63
		254 mm (10")	60	59	63	63.3
		305 mm (12")	62	60	65	65.9
<b>Light Intensity</b>		≥ 1200 lux (111 ft-cd)				
<b>Electrical Rating (8) 220-230 VAC 50/60V</b>	Nominal power (Watt)	203 mm (8")	160	190	350	366
		254 mm (10")	195	201	374	420
		305 mm (12")	228	236	455	550
	Heat Load (BTU/hr)	203 mm (8")	546	648	1194	1249
		254 mm (10")	665	686	1276	1433
		305 mm (12")	778	805	1553	1877
	Full Load Amps exclude 5A EO	203 mm (8")	6 A		10 A	
		254 mm (10")	6 A		10 A	
		305 mm (12")	6 A		10 A	
<b>Electrical Rating (9) 110-120 VAC 50/60V</b>	Nominal power (Watt)	203 mm (8")	163	193	355	372
		254 mm (10")	203	205	380	421
		305 mm (12")	232	240	380	537
	Heat Load (BTU/hr)	203 mm (8")	556	659	1211	1269
		254 mm (10")	693	699	1297	1471
		305 mm (12")	792	819	1570	1832
	Full Load Amps exclude 5A EO	203 mm (8")	10 A		16 A	
		254 mm (10")	10 A		16 A	
		305 mm (12")	10 A		16 A	
Optional Outlets FLA		5A				

Disclaimer: Technical Specifications may be subjected to further changes without prior notice.

\*Noise reading in open field condition / anechoic chamber. Noise reading in normal room varies by room size, layout, and background noise, but may reach roughly 3-4 dBA above these values.

\*\*Electrical power consumption is an measurement of new unit with clean filter operated within nominal setpoint. Result per unit may vary.

## TECHNICAL SPECIFICATIONS

Labculture® Class II	Stainless Steel Side Walls	220-240 VAC, 50/60 Hz	LA2-3S8 G4 8" 2011666	LA2-4S8 G4 8" 2011668	LA2-5S8 G4 8" 2011670	LA2-6S8 G4 8" 2011672
			LA2-3S8 G4 10" 2011682	LA2-4S8 G4 10" 2011684	LA2-5S8 G4 10" 2011686	LA2-6S8 G4 10" 2011688
			LA2-3S8 G4 12" 2011714	LA2-4S8 G4 12" 2011716	LA2-5S8 G4 12" 2011718	LA2-6S8 G4 12" 2011720
		110-130 VAC, 50/60 Hz	LA2-3S9 G4 8" 2011667	LA2-4S9 G4 8" 2011669	LA2-5S9 G4 8" 2011671	LA2-6S9 G4 8" 2011673
			LA2-3S9 G4 10" 2011683	LA2-4S9 G4 10" 2011685	LA2-5S9 G4 10" 2011687	LA2-6S9 G4 10" 2011689
			LA2-3S9 G4 12" 2011715	LA2-4S9 G4 12" 2011717	LA2-5S9 G4 12" 2011719	LA2-6S9 G4 12" 2011721
Cabinet Construction	Main body	Electro-galvanized steel with white oven-baked epoxy-polyester Isocide™ antimicrobial powder-coated finish, 1.5 mm (0.06") / 16 gauge thick				
	Work Zone	Stainless steel type 304 with no.4 finish, 1.5 mm (0.06") / 16 gauge thick				
	Sash Window	6 mm tempered glass				
Net Weight		243 Kg (536 lbs)	287 Kg (633 lbs)	381 Kg (840 lbs)	400 kg (882 lbs)	
Shipping Weight		304 kg (644 lbs)	360 kg (772 lbs)	451 kg (968 lbs)	506 kg (1116 lbs)	
Shipping Dimensions, Maximum (W x D x H)		1185 x 950 x 2120 mm (46.7" x 37.4" x 83.5")	1490 x 950 x 2120 mm (58.7" x 37.4" x 83.5")	1950 x 950 x 2120 mm (76.8" x 37.4" x 83.5")	2200 x 950 x 2120 mm (86.6" x 37.4" x 83.5")	
Shipping Volume		2.3 m³ (81.2 cu. ft.)	3 m³ (105.9 cu. ft.)	3.9 m³ (137.7 cu. ft.)	4.4 m³ (155.4 cu. ft.)	

## Options and Accessories

Anti-blowback Valve 10 inches	EG Powder-Coated	ANTI-BLOW BACK VALVE 10" ABBV-10P 5170352			
	304 Stainless Steel	ANTI-BLOW BACK VALVE 10" ABBV-10S 5170354			
Exhaust Collar		ECO-F1-LA2/AC2/LR2/AR-3FT G4 5171097	ECO-F1-LA2/AC2/LR2/AR2/VA2-4FT G4 5171098	ECO-F1-LA2/AC2/LR2/AR2-SFT G4 5171099	ECO-F1-LA2/AC2/LR2/AR2/VA2-6FT G4 5171100
UV Lamp		UV-15A (5170251)	UV-30A (5170255)		
IV Bar		IV-910 (5170499)	IV-1215 (5170231)	IV-1520 (5170500)	IV-1825 (5170501)
Electrical Outlet	Direct Mounted	EO-H_			
	GFCI	EO-GFCI (5170071)			
Service Fixtures	EU SF-Gas-20 mm and Solenoid Valve	SF-1G20 (5170410)			
	EU SF-Vacuum-20 mm	SF-1V20 (5170457)			
	EU SF-Air-20 mm	SF-1A20 (5170502)			
	EU SF-Nitrogen-20 mm	SF-1N20 (5170503)			
	EU SF-Water-20 mm	SF-1W20 (5170458)			
	US SF-Universal-20 mm	SF-2U22 (5170504)			
	Copper Piping for SF	CU-Pipe (5170026)			
Support Stand (705 to 915 mm with 50 mm increment / 28.0" to 36.0" with 2" increment, combination of caster wheels and leveling feet)		STA-3A0 5131340	STA-4A0 5131341	STA-5A0 5131427	STA-6A0 5131389
Stainless Steel Pipette Storage Shelf		5260327			
Arm Rest Padding		MEWREST (5170127)			
Foot Rest		FT-REST (5170073)			
Laboratory Chair		ME-LD-AR360 (1150006)			
IQ OQ Protocol		9010179			



ABBV\_

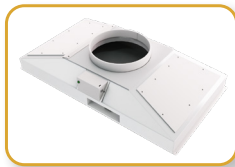

ECO-F-LA2-4 G4



UV\_A-L

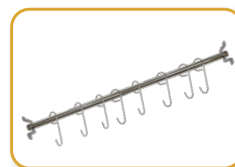

IV\_



EO-H\_



EO-GFCI

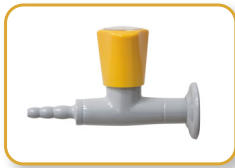

SF-1\_



SF-2U\_



STA\_



SS Pipette Storage Shelf



MEWREST



FT-REST



ME-LD-AR360



IQOQ

# ESCO

LIFESCIENCES GROUP

*Improving Lives through Science*

## ESCO SCIENTIFIC



- Animal Research Workstation
- Biological Safety Cabinet
- CO<sub>2</sub> Incubator
- Ducted Fume Hood
- Ductless Fume Hood
- Filtered Storage Cabinet
- Laboratory Centrifuge
- Laboratory Oven and Incubator
- Laboratory Refrigerator and Freezer
- Laboratory Shaker
- Laminar Flow Cabinet
- PCR Cabinet
- Powder Weighing Balance Enclosure
- Thermal Cycler
- Ultra-low Temperature Freezer

## ESCO MEDICAL



- Time-Lapse Incubator
- Benchtop Incubator
- ART Workstation
- CO<sub>2</sub> Incubator
- Anti-Vibration Table
- Gas Analyser

## ESCO Healthcare

"Discovery to Delivery"



ESCO  
PHARMA

ESCO  
TaPestle

ESCO  
VACCIXCELL

Pharmaceutical Manufacturing, Pharmacy Compounding,  
and Bioprocessing Tools

## ESCO ASTER



CRDMO Services

# ESCO LIFESCIENCES GROUP

42 LOCATIONS IN 21 COUNTRIES ALL OVER THE WORLD

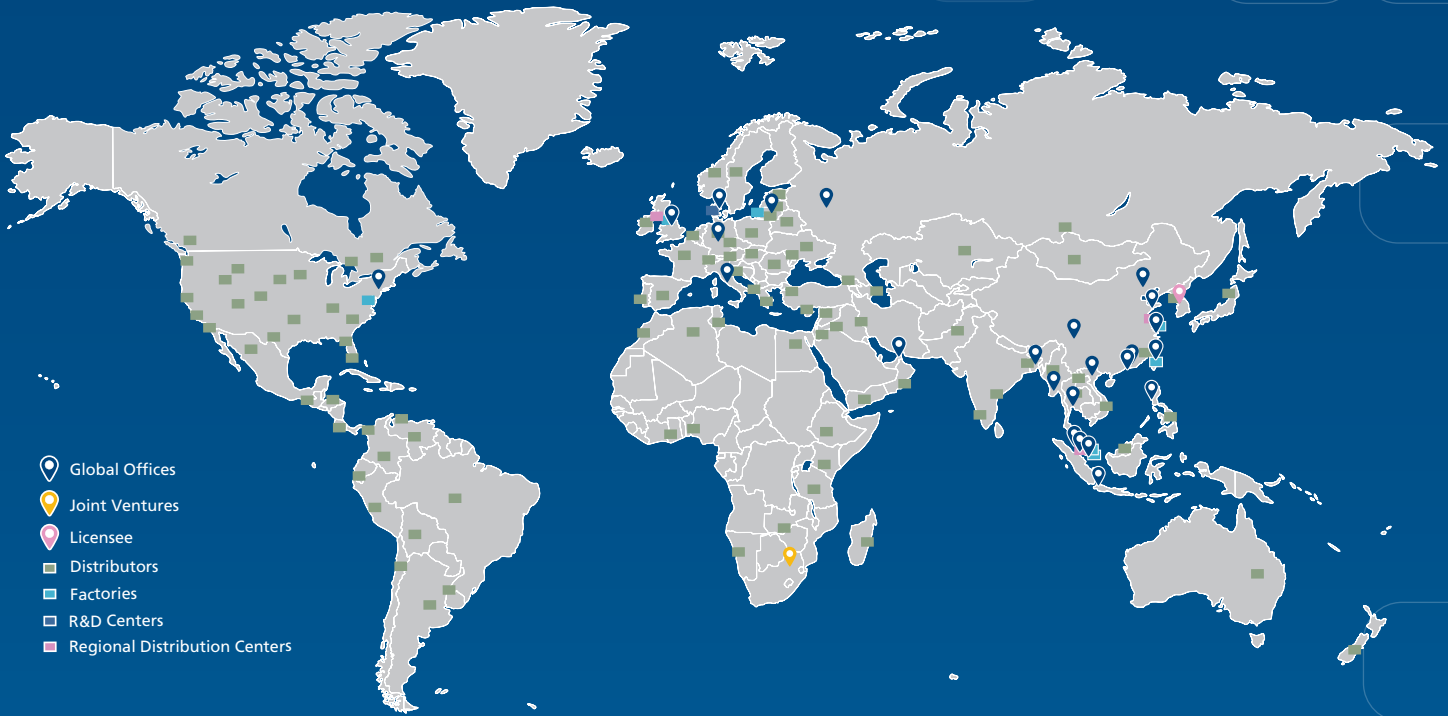

- 📍 Global Offices
- 📍 Joint Ventures
- 📍 Licensee
- 📍 Distributors
- 📍 Factories
- 📍 R&D Centers
- 📍 Regional Distribution Centers

Follow us on social media, download our apps,  
and scan the QR code for more info.



@EscoLifesciences



@EscoLifesciences



@EscoLifesci



@Esco



@EscoLifesciences



@EscoLifesciences



Esco Lifesciences



Esco Lifesciences

# ESCO

LIFESCIENCES GROUP

Esco Micro Pte. Ltd. • 19 Changi South Street 1 • Singapore 486779  
Tel +65 6542 0833 • mail@escolifesciences.com  
www.escolifesciences.com

Esco Technologies, Inc. • 903 Sheehy Drive, Suite F, Horsham, PA 19044, USA  
Tel: +1 215-441-9661 • eti.admin@escolifesciences.com

Esco Lifesciences Group Offices: Bangladesh | China | Denmark | Germany | Hong Kong | India | Indonesia | Italy | Japan | Lithuania  
| Malaysia | Myanmar | Philippines | Russia | Singapore | South Africa | South Korea | Taiwan | Thailand | UAE | UK | USA | Vietnam

9010598\_Labculture Gen 4-BSC-Global-A4\_vC\_040324

Esco can accept no responsibility for possible errors in catalogues, brochures and other printed materials. Esco reserves the right to alter its products and specifications without notice. All trademarks and logotypes in this material are the property of Esco and the respective companies.